

## Results from a German terminology mapping effort: intra- and interdisciplinary cross-concordances between controlled vocabularies

Philipp Mayr, Vivien Petras, Anne-Kathrin Walter  
GESIS Social Science Information Centre,  
Bonn, Germany

Budapest, September 21, 2007

# Outline

- Introduction & background
- Project KoMoHe
- Controlled vocabularies & cross-concordances
- Database and HTS
- Evaluation effort
- Summary & Outlook
- Demo (Online-Thesaurus)

# Introduction

## Theoretical background

- Vagueness between terms
  - Language ambiguity
  - Meaning of terms
- Semantic heterogeneity in document collections
- Problems while indexing documents
  - Consistency
  - Precision
  - Topicality

# Background

## 2 step methodology

- V1: between user terms and document terms
- V2: between document terms in different collections

Cross-concordances are used for V2 and V3

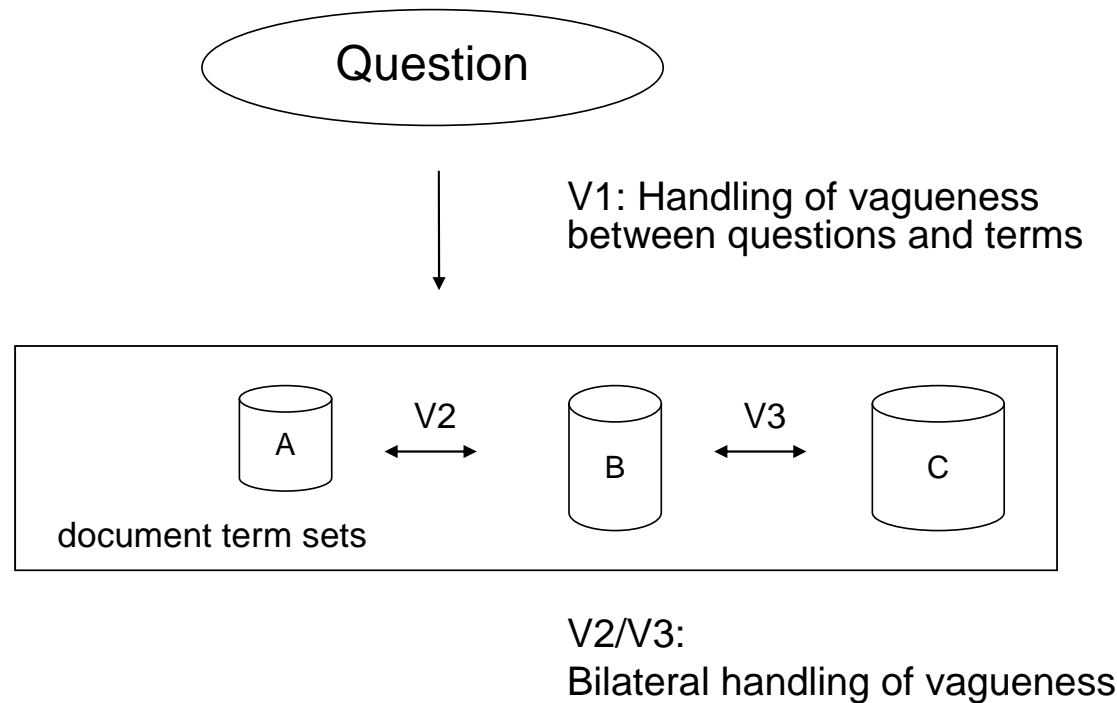

# Project - background

vascoda approach: an interdisciplinary portal (DL) for scientific information

- Transfers queries to specialized portals
- Covers information services from more than 40 partners

Consequences:

- Very complex structures (dozens of collections, schemata, interfaces, indexing languages, ...)
- Necessity for semantic integration of relevant information services

The screenshot displays the vascoda search interface. At the top, there is a search bar with the text "Search for:" and a search button labeled "Start search". Below the search bar, there is a dropdown menu set to "all of these words" and a link for "Advanced search". The "Search in:" section offers two options: "vascoda subject gateway" (selected) and "vascoda subject list" (with a "Select subjects" link). Under "vascoda subject gateway", four categories are listed with checkboxes: "Engineering and Physical Sciences", "Life Sciences", "Law, Economics and Social Sciences", and "Humanities and Area Studies". A "Deutsche Version" link is visible at the bottom left. Below the search interface, a "Subject Gateways" section features four colored buttons: blue for "Engineering and Physical Sciences", dark blue for "Life Sciences", red for "Law, Economics and Social Sciences", and green for "Humanities and Area Studies". Each button includes a "[more information]" link.

# Project

Title: Kompetenzzentrum Modellbildung und Heterogenitätsbehandlung (Competence Center Modeling and Treatment of Semantic Heterogeneity)

Financing: Federal Ministry of Education and Research (Bundesministerium für Bildung und Forschung, BMBF)

Subproject of "Kompetenznetzwerk Neue Dienste, Standardisierung, Metadaten" (Competence Network: New Services, Standardization, Metadata)

Persons involved: Jürgen Krause, Philipp Mayr, Vivien Petras, Max Stempfhuber, Anne-Kathrin Walter

Project Duration: September 2004 through August 2007

# Project

Task: creation, organization and management of cross-concordances

Modeling and implementation of modules to treat semantic heterogeneity for vascoda collections

Largest terminology mapping effort in Germany

First major effort to evaluate the results of using cross-concordance for distributed retrieval

# Controlled vocabularies

Various types of KOS: thesauri, classification systems, subject heading lists, descriptor lists

Cross-concordances for vascoda (respective sowiport)

- Mainly KOS centred around the social sciences
- Other disciplines are covered

25 KOS altogether



# Controlled vocabularies

Types of KOS: Thesauri (16), Descriptor lists (4), Classifications (3), Subject headings (2)

Sizes of KOS: between 1,000 and 17,000 mapped terms; some KOS are mapped partly because of their size

Subjects of KOS: social science and related, political science, economics, medicine – subject specific parts of universal vocabularies

# Controlled vocabularies - disciplines

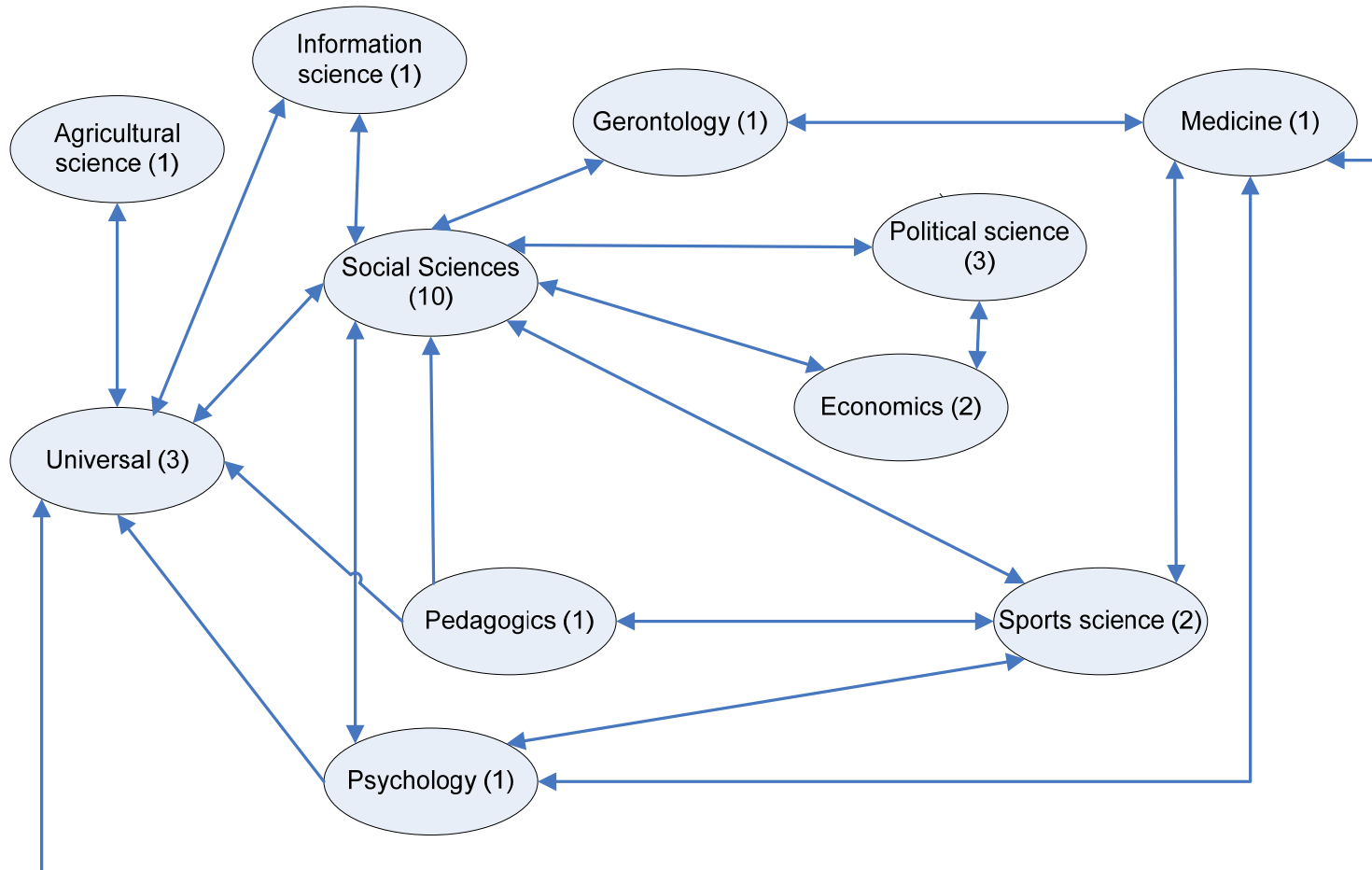

# Controlled vocabularies – overview 1

	Vocabular	Name	Subject	Type	Mapped
1	AGROVOC	AGROVOC Thesaurus	agricultural science	Thesaurus	part
2	CSA-ASSIA	CSA Thesaurus Applied Social Sciences Index and Abstracts	social sciences	Thesaurus	complete
3	CSA-WPSA	CSA Thesaurus of Political Science Indexing Terms	social sciences	Thesaurus	complete
4	CSA-PAIS	CSA Thesaurus PAIS International Subject Headings	political science	Thesaurus	complete
5	CSA-PEI	CSA Thesaurus Physical Education Index		Thesaurus	complete
6	FES	Descriptors of the Friedrich-Ebert Stiftung	social sciences	Descriptor list	complete
7	BISp	Descriptors of the Bundesinstitut für Sportwissenschaft	sports science	Descriptor list	complete
8	INION	Descriptors of the Institute of Scientific Information on Social Sciences of the Russian Academy of Sciences	social sciences	Descriptor list	part
9	IAB	Descriptors of the Institut für Arbeitsmarkt- und Berufsforschung	social sciences	Descriptor list	complete
10	DDC	Dewey Decimal Classification	universal	Classification	part
11	ELSST	European Language Social Science Thesaurus	social sciences	Thesaurus	complete
12	INFODATA	INFODATA Thesaurus	information science	Thesaurus	complete
13	JEL	Journal of Economic Literature Classification System	economics	Classification	complete
14	MeSH	Medical Subject Headings	medicine	Subject Headings	part
15	Psyndex	Psyndex Terms	psychology	Thesaurus	complete

# Controlled vocabularies – overview 2

16	RVK	Regensburger Verbundklassifikation	universal	Classification	part
17	SWD	Schlagwortnormdatei	universal	Subject Headings	part
18	STW	Standard Thesaurus Wirtschaft	economics	Thesaurus	complete
19	Bildung	Thesaurus Bildung	pedagogics	Thesaurus	part
20	DZI	Thesaurus of the Deutschen Instituts für soziale Fragen	social sciences	Thesaurus	complete
21	GEROLIT	Thesaurus of the Deutschen Zentrums für Altersfragen	social sciences	Thesaurus	complete
22	TWSE	Thesaurus für wirtschaftliche und soziale Entwicklung	political science	Thesaurus	complete
23	IBLK	Thesaurus Internationale Beziehungen und Länderkunde (Euro-Thesaurus)	political science	Thesaurus	complete
24	CSA-SA	Thesaurus of Sociological Indexing Terms	social sciences	Thesaurus	complete
25	TheSoz	Thesaurus Sozialwissenschaften	social sciences	Thesaurus	complete

# Cross-concordances

Definition: Directed, relevance evaluated/estimated relations between controlled terms of two KOS

Most KOS were bilaterally mapped, but not always symmetrically or completely.

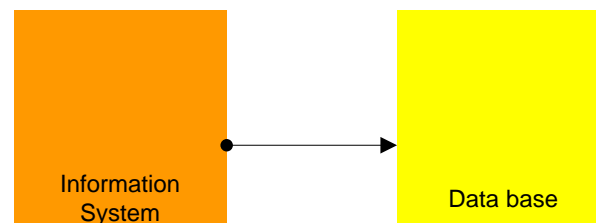
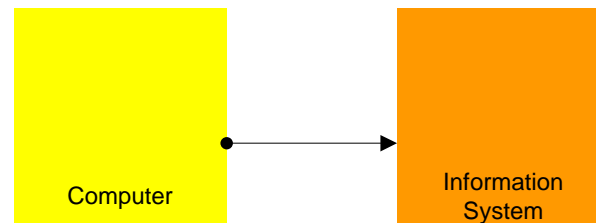
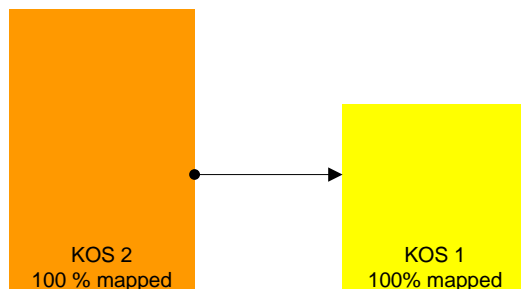
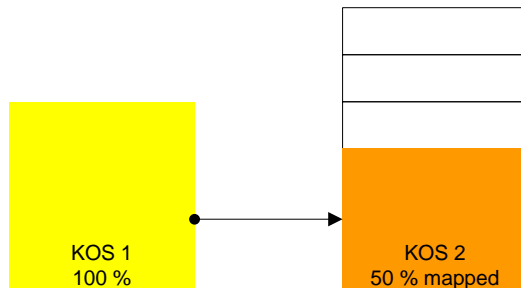

## Cross-concordances - steps

- Estimation of the costs for an inter-thesaurus mapping
  - Analysis of the vocabularies
  - Sizes of the vocabularies
  - Topical overlap
- Selection of the cross-concordance contributors and partners
  - Mostly indexers & terminology workers
  - Institutions holding the rights of a vocabulary
- Project coordination and quality assurance
  - Review of parts of the relations (semantics)
  - Recall measures & syntax check
- Import into the cross-concordance database
- Integration in the terminology service (heterogeneity web service)

## Cross-concordances

Mapping is done intellectually by: researchers, terminology experts, domain experts, postgraduates

Practical rules and guidelines:

1. Use intra thesaurus relations (e.g. ND->D)
2. Test the recall and precision of combinations
3. Relevances of the relations are normally depended on the relation type
4. Use 1:1 relations first
5. Map word groups consistently

# Cross-concordances

## Workflow

1. Understand the meaning of a start descriptor (use start thesaurus relations and database)
2. Search term in end thesaurus
  - Search word stem
  - Search equivalence, synonyms
  - Stop if you find an equivalence, otherwise build a combination or an other relation type
3. Map the term in the cross-concordance file
4. Add a relevance for the relation



# Cross-concordances - examples

Equivalence (=) means identity, synonym, quasi-synonym

Hierarchy (< >)

- Broader terms (<) from a narrower to a broad
- Narrower terms (>) from a broad to a narrower

Association (^) for related terms

Null (0) no mapping possible

- Additional relevance for Relations

(high, medium, low)

term KOS 1	relation	term(s) KOS n
hacker	=	Hacking
hacker	^+	Computers + Crime
hacker	^+	Internet + Security
ISDN	0	
ISDN	<	Telecommunications
documentation system	>	Abstracting services

# Cross-concordances - overview

	Voc. name	Voc. name	type	status	year
1	TheSoz	STW	bilateral	imported	2004
2	TheSoz	BiSp	bilateral	imported	2004
3	Psyndex	BISp	bilateral	imported	2004
4	BISp	Bildung		imported	2004
5	TheSoz	DZI	bilateral	imported	2005
6	TheSoz	FES	bilateral	imported	2005
7	TheSoz	IBLK	bilateral	imported	2005
8	TheSoz	Gerolit	bilateral	imported	2005
9	MeSH	BISp	bilateral	imported	2005
10	STW	IBLK	bilateral	imported	2005
11	TheSoz	CSA-WPSA	bilateral	imported	2006
12	TheSoz	CSA-ASSIA	bilateral	imported	2006
13	TheSoz	ELSST	bilateral	imported	2006
14	TheSoz	CSA-PEI	bilateral	imported	2006
15	MeSH	Psyndex	bilateral	imported	2006
16	MeSH	Gerolit	bilateral	imported	2006
17	IBLK	CSA-PAIS	bilateral	imported	2006
18	IBLK	TWSE	bilateral	imported	2006
19	INION	TheSoz			2007
20	INFODATA	SWD	bilateral	imported	2007
21	INFODATA	TheSoz	bilateral	imported	2007
22	IAB	TheSoz	bilateral	imported	2007
23	IAB	STW	bilateral	imported	2007
24	SWD	MeSH	bilateral		2007
25	SWD	AGROVOC	bilateral		2007
26	JEL	STW		ready	2007
27	RVK	DDC		ready	2007

7 further mappings from the previous projects infoconnex and CARMEN

## Data base

Vocabularies: 25

Mappings: 28 bilateral, 6 unilateral

Size: round 396,000 relations to date

Concepts: round 124,000 (incl. combinations)

Cross-concordance relations:

- Equivalence: 165,000 (42%)
- Broader: 84,000 (21%)
- Narrower: 36,000 (9%)
- Association: 56,000 (14%)
- Null: 56,000 (14%)

# Heterogeneity Service (HTS)

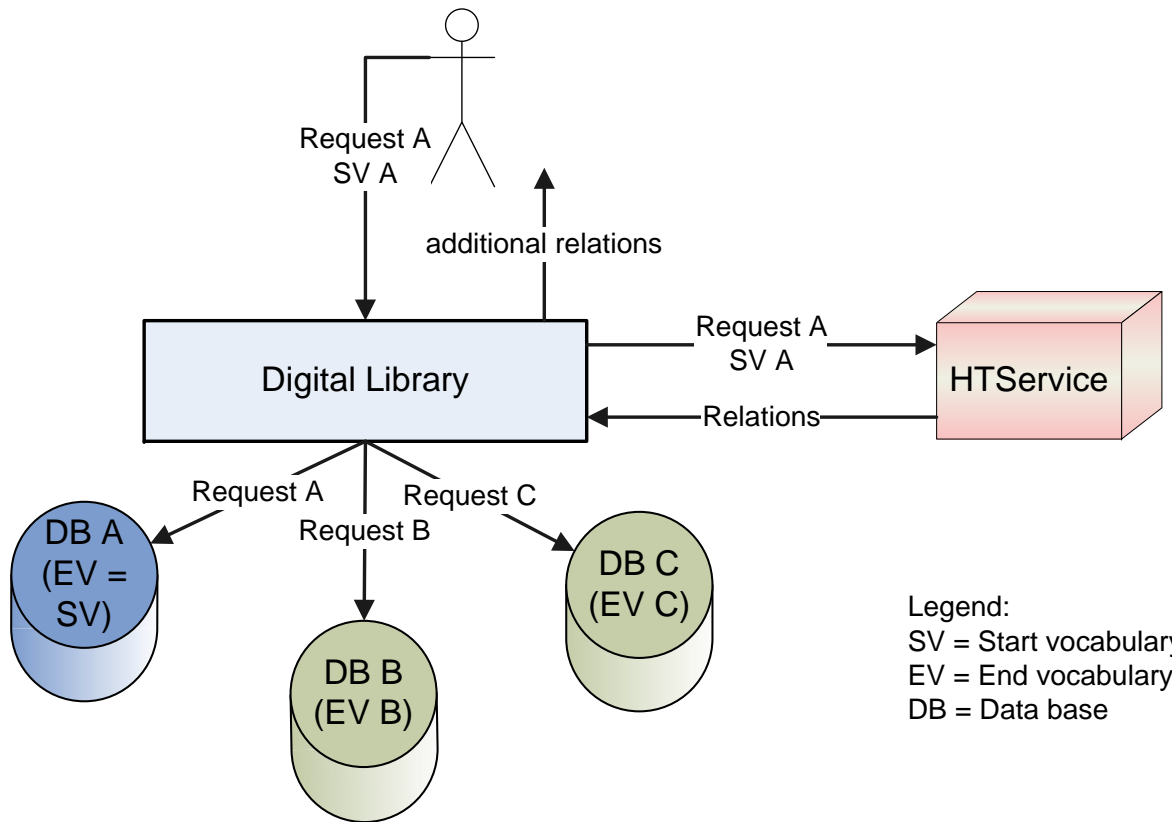

Legend:  
 SV = Start vocabulary  
 EV = End vocabulary  
 DB = Data base

2 scenarios

- Just transform into equivalence relations
- Present additional relations to users

# Heterogeneity Service

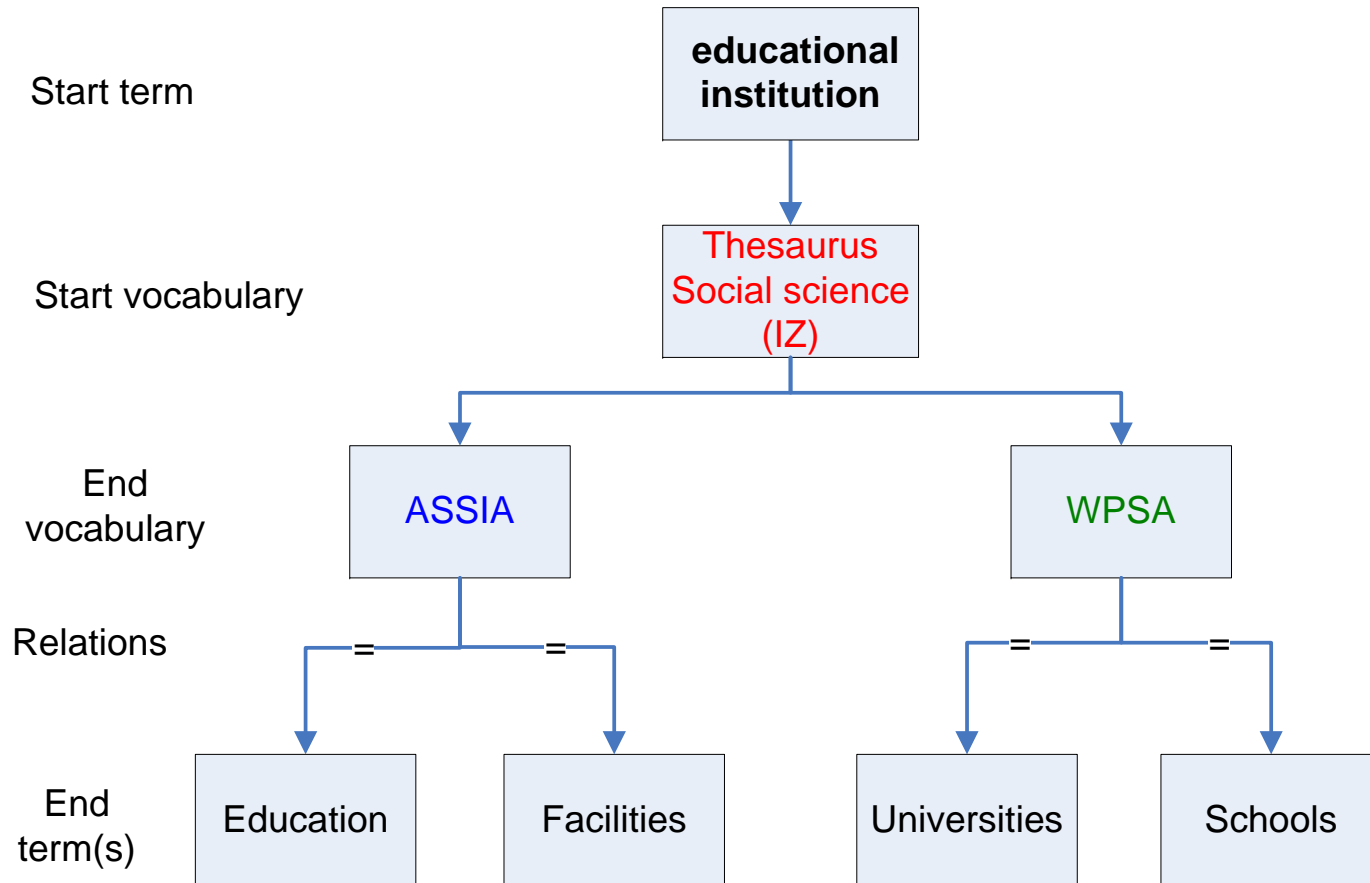

# Evaluation

To date only very small evaluations in previous projects

Do cross-concordances improve search?

How?

Objective: to test and measure the effectiveness of cross-concordance in an real distributed environment

Questions:

- Exactness of the relations
- Relevance of the additional documents
- Intra- vs. Interdisciplinary cross-concordances

Measuring: quantitative analysis and retrieval test

## Evaluation - Quantitative analysis

Objective: find trends in the cross-concordances

- depended on the subject and structure of the vocabularies

Measures:

- Distribution of relations
- Ratio of mapped term in the end vocabulary
- Ratio of identities (term a is exact the same as term b)
- Relations for an end term or concept

## Evaluation – preliminary results

In the same discipline generally more equivalence relations (TheSoz, DZI, SWD)

- Exact match in the same discipline is high
- Exact match in the same language is high (German)

In interdisciplinary cross-concordances generally more associations and Null relations (TheSoz, Psyndex, STW, IBLK, MeSH)

But differences in creating the cross-concordances (human factor) are visible



## Evaluation – Retrieval test

Objective: value-added for the user (additional documents)

Task: Evaluating real user topics (operationalized in controlled terms)

1. Free text query (FT)
2. Descriptor query in the controlled term field (CT)
3. Translated descriptors via cross-concordance (only EQ-relations) (TT)

Relevance assessment of the retrieved documents

# Evaluation – Retrieval test

## Steps:

1. Real user topics by partners (in operationalized form)
2. Formulation of the queries and pretest of the test
3. Searching the databases (3 queries for a topic) and download of the documents (max. 1,000 doc)
4. Import of the documents in assessment tool and assessment of the documents
5. Analysis of the assessments

## Evaluation – Retrieval test

### Collections:

Test 1 - Social sciences: SOLIS, CSA Sociological Abstracts, SoLit, OPAC University Library Cologne

Test 2 - Social sciences interdisciplinary: SOLIS, Econis, Psyndex

Test 3 - Interdisciplinary: Medline, Psyndex, Econis, World Affairs online

Topics: between 5-10 for a mapping

Documents: max. 1,000 documents for a topic, documents are not ranked

## Evaluation – preliminary results

Recall is the percentage of retrieved relevant documents out of all relevant documents

Precision is the percentage of relevant documents out of the retrieved doc.

# Evaluation – preliminary results

- TT improves over CT, but not necessarily over FT
- FT generates more doc (FT search controlled terms too)

SWD-TheSoz		CT	TT	FT
5 topics	Recall	<b>0,5817</b>	<b>0,5817</b>	<b>0,684</b>
	Precision	<b>0,3663</b>	<b>0,3663</b>	<b>0,3642</b>

TheSoz-DZI		CT	TT	FT
10 topics	Recall	<b>0.5907</b>	<b>0.7602</b>	<b>0.5327</b>
	Precision	<b>0.3173</b>	<b>0.3914</b>	<b>0.6760</b>

STW-TheSoz		CT	TT	FT
6 topics	Recall	<b>0.2807</b>	<b>0.5859</b>	<b>0.5944</b>
	Precision	<b>0.2351</b>	<b>0.3634</b>	<b>0.3199</b>

## Summary & Outlook

All related cross-concordances will be used in sowiport

Results of the quantitative and retrieval evaluation will be finished next month

Other relation types and their utilization in search

Indirect term transformations (experiments)

Merging V1 treatment (V1 is the vagueness between user terms and descriptors) and cross-concordances

# Online-Thesaurus

## Thesaurus for the Social Sciences

Information Contact

type your search term

Deutsch English **русский**

alphabetic systematic

Show/Hide: Translation  Cross concordance

- 3.5.00: Science
  - scientific institution
  - scientific literature
  - scientific revolution
  - scientific cooperation
  - scientific character
  - scientific-technical revolution
  - application of science
  - scientific scene
  - scientific discipline
  - development of science
  - science ethics
  - promotion of science
  - blind faith in science
  - organization of science
  - planning of science
  - science policy
  - Science Council
  - language of science
  - systematics of science
  - science transfer
- + 3.5.01: Culture, Customs
- + 3.5.02: Art, Music, Theater
- + 3.5.03: Religion
- + 3.6: Leisure Time, Sports, Tourism
- + 3.7: Environment, Ecology
- + 4: Special Social Sciences
- + 5: Special Lists of Terms

**scientific institution**

---

**Broader Term**

facility

---

**Used in combination with**

funding for *research financing*

---

**Notation**

3.5.00 Science

**Cross concordance**

<input type="checkbox"/> BISp	<input type="checkbox"/> GEROLIT
<input checked="" type="checkbox"/> CSA-ASSIA	<input type="checkbox"/> IAB
<input type="checkbox"/> CSA-PEI	<input checked="" type="checkbox"/> IBLK
<input checked="" type="checkbox"/> CSA-SA	<input type="checkbox"/> IIFODATA
<input checked="" type="checkbox"/> CSA-WPSA	<input checked="" type="checkbox"/> PSYINDEX
<input type="checkbox"/> DZI	<input checked="" type="checkbox"/> STW
<input type="checkbox"/> ELSST	<input type="checkbox"/> SWD
<input type="checkbox"/> FES	

---

**IZ-CSA-ASSIA**

Science + Institutions

---

**IZ-CSA-SA**

Science + Institutes

---

**IZ-CSA-WPSA**

Institutes

---

**IZ-IBLK**

- >o Staatliche wissenschaftliche Einrichtung
- >o Internationale wissenschaftliche Einrichtung
- >o Halbstaatliche wissenschaftliche Einrichtung
- >o Wissenschaftliche Arbeitsgruppe

Available at

<http://vt-app.bonn.iz-soz.de/thesaurusbrowser/servlet/ThesaurusSession?lang=en>

# Online-Thesaurus

Information Contact

Deutsch English русский

Show/Hide: Translation  Cross concordance

## Cross concordance

- |   |                                   |
|---|-----------------------------------|
| <input type="checkbox"/> BISP                 | <input type="checkbox"/> GEROLIT  |
| <input checked="" type="checkbox"/> CSA-ASSIA | <input type="checkbox"/> IAB      |
| <input type="checkbox"/> CSA-PEI              | <input type="checkbox"/> IBLK     |
| <input checked="" type="checkbox"/> CSA-SA    | <input type="checkbox"/> IIFODATA |
| <input checked="" type="checkbox"/> CSA-WPSA  | <input type="checkbox"/> PSYINDEX |
| <input type="checkbox"/> DZI                  | <input type="checkbox"/> STW      |
| <input type="checkbox"/> ELSST                | <input type="checkbox"/> SWD      |
| <input type="checkbox"/> FES                  |                                   |

### IZ-CSA-ASSIA

Scientific Management

### IZ-CSA-SA

Scientific Research

### IZ-CSA-WPSA

Scientific Community

1) Scientific scene

Deutsch English русский

Translation  Cross concordance

## Cross concordance

- |   |                                   |
|---|-----------------------------------|
| <input type="checkbox"/> BISP                 | <input type="checkbox"/> GEROLIT  |
| <input checked="" type="checkbox"/> CSA-ASSIA | <input type="checkbox"/> IAB      |
| <input type="checkbox"/> CSA-PEI              | <input type="checkbox"/> IBLK     |
| <input checked="" type="checkbox"/> CSA-SA    | <input type="checkbox"/> IIFODATA |
| <input checked="" type="checkbox"/> CSA-WPSA  | <input type="checkbox"/> PSYINDEX |
| <input type="checkbox"/> DZI                  | <input type="checkbox"/> STW      |
| <input type="checkbox"/> ELSST                | <input type="checkbox"/> SWD      |
| <input type="checkbox"/> FES                  |                                   |

### IZ-CSA-ASSIA

States + Religions

### IZ-CSA-SA

Church State Relationship

### IZ-CSA-WPSA

Church State Relationship

Churches + State

2) State church

Information Contact

Deutsch English русский

Translation  Cross concordance

## Cross concordance

- |                                    |  |
|------------------------------------|--|
| <input type="checkbox"/> BISP      | <input checked="" type="checkbox"/> GEROLIT  |
| <input type="checkbox"/> CSA-ASSIA | <input checked="" type="checkbox"/> IAB      |
| <input type="checkbox"/> CSA-PEI   | <input checked="" type="checkbox"/> IBLK     |
| <input type="checkbox"/> CSA-SA    | <input checked="" type="checkbox"/> IIFODATA |
| <input type="checkbox"/> CSA-WPSA  | <input checked="" type="checkbox"/> PSYINDEX |
| <input type="checkbox"/> DZI       | <input checked="" type="checkbox"/> STW      |
| <input type="checkbox"/> ELSST     | <input checked="" type="checkbox"/> SWD      |
| <input type="checkbox"/> FES       |  |

### IZ-GEROLIT

Kirchen

### IZ-IAB

Kirche

### IZ-IBLK

Staatsreligion

### IZ-IIFODATA

no entry

### IZ-PSYINDEX

(null)

### IZ-STW

Kirche

### IZ-SWD

Staatskirche



# Heterogeneity Service

```

- <termrelations>
  - <term role="start" startThesaurusName="Thesaurus Sozialwissenschaften" endCollectionName="csa-sa" text="Staatskirche" endThesaurusName="CSA-SA">
    <term text="Church State Relationship" role="end"/>
  </term>
  - <term role="start" startThesaurusName="Thesaurus Sozialwissenschaften" endCollectionName="csa-ssa" text="Staatskirche" endThesaurusName="CSA-SA">
    <term text="Church State Relationship" role="end"/>
  </term>
  - <term role="start" startThesaurusName="Thesaurus Sozialwissenschaften" endCollectionName="fes-bib" text="Staatskirche" endThesaurusName="FES">
    <term text="Kirche und Staat" role="end"/>
  </term>
  - <term role="start" startThesaurusName="Thesaurus Sozialwissenschaften" endCollectionName="dza-gerolit" text="Staatskirche" endThesaurusName="DZA">
    <term text="Kirchen" role="end"/>
  </term>
  - <term role="start" startThesaurusName="Thesaurus Sozialwissenschaften" endCollectionName="dzi-solit" text="Staatskirche" endThesaurusName="DZI">
    <term text="Staat" role="end"/>
    <term text="Kirche" role="end"/>
  </term>
  - <term role="start" startThesaurusName="Schlagwortnormdatei" endCollectionName="iz-foris" text="Staatskirche" endThesaurusName="Thesaurus Sozialwissen">
    <term text="Staatskirche" role="end"/>
  </term>
  - <term role="start" startThesaurusName="Schlagwortnormdatei" endCollectionName="iz-solis" text="Staatskirche" endThesaurusName="Thesaurus Sozialwissen">
    <term text="Staatskirche" role="end"/>
  </term>
  - <term role="start" startThesaurusName="Thesaurus Sozialwissenschaften" endCollectionName="swp-iblk" text="Staatskirche" endThesaurusName="IBLK">
    <term text="Staatsreligion" role="end"/>
  </term>
</termrelations>

```

Project „Competence Center Modeling  
and Treatment of Semantic  
Heterogeneity”:

[http://www.gesis.org/en/research/  
information\\_technology/komohe.htm](http://www.gesis.org/en/research/information_technology/komohe.htm)

Email:

[philipp.mayr@gesis.org](mailto:philipp.mayr@gesis.org)

[vivien.petras@gesis.org](mailto:vivien.petras@gesis.org)